



P.O. Box 66
 Fork Union, VA 23055
 p (434) 842-1851
 info@vsi-supply.com
 www.vsi-supply.com

Aqua Safe
 AS600-CDB
 Concrete Deep Burial
 Tank



Deep Burial Concrete Top

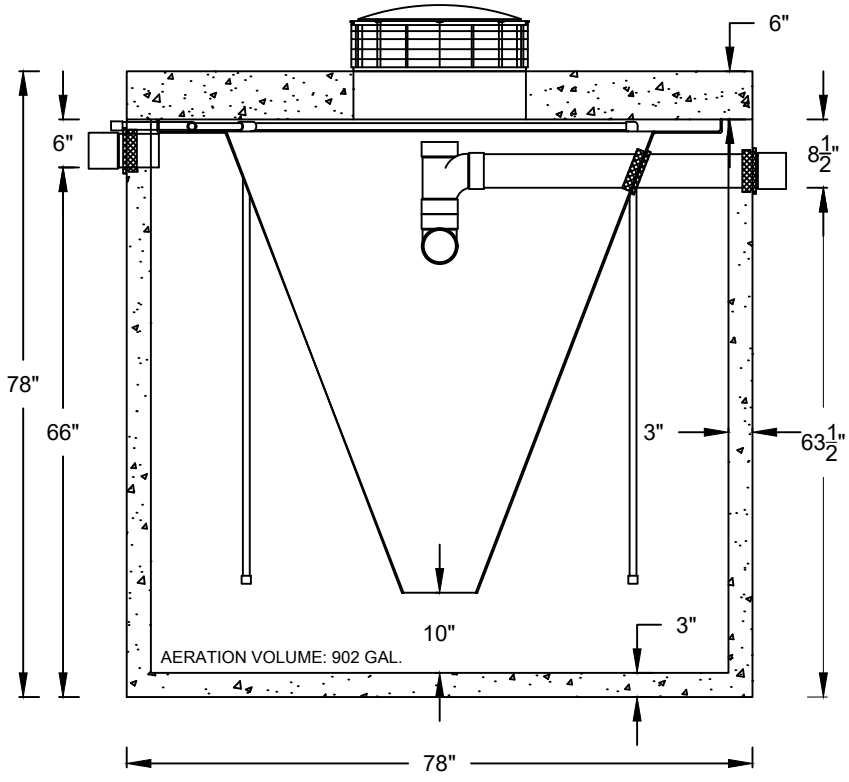
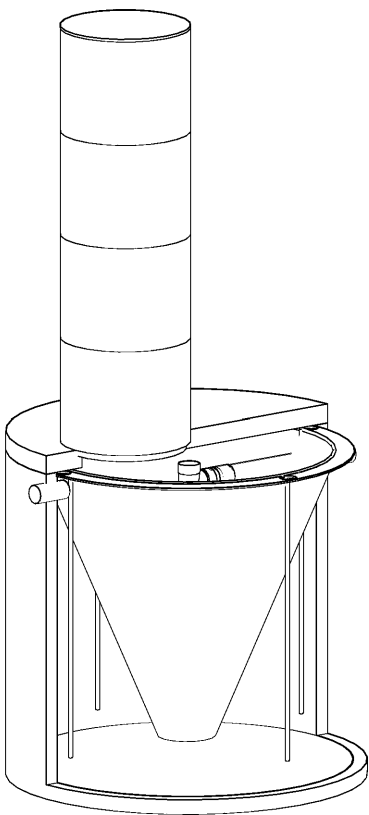
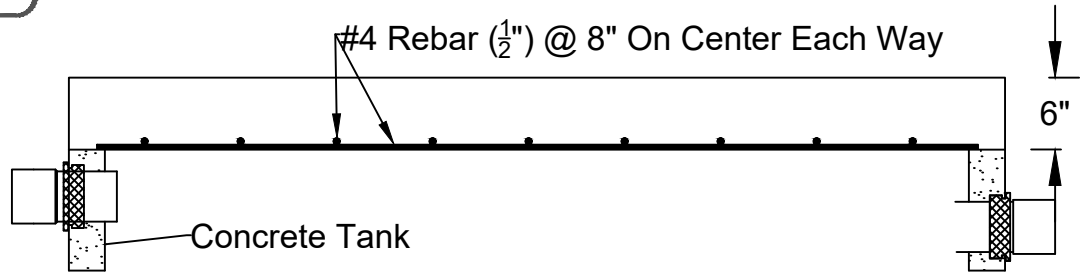

Riser Options

- 24" Dia x 12" Height Tuf-Tite Riser (Plastic)
- 24" Dia x 24" Height Concrete Riser

Lid Options

- 24" Domed Tuf-Tite Lid (Z4-RISL)
- 22 $\frac{3}{4}$ " Cast Iron Manhole Frame w/ Solid Top

Structural Notes:

- Major Codes and Standards
- 2021 Virginia Residential Code

- Design Loads
- Dead Loads Up to 8' Of Fill
- Live Loads HS-20 Wheel Load